

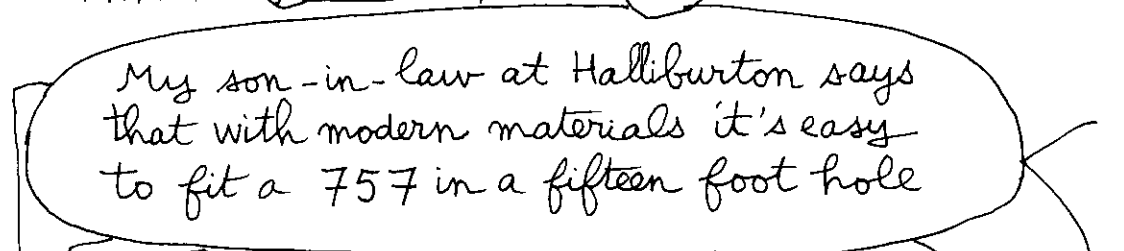

HELPING GEORGE

Signs of the Times presents
LARTIE SHAW & TOM HAT

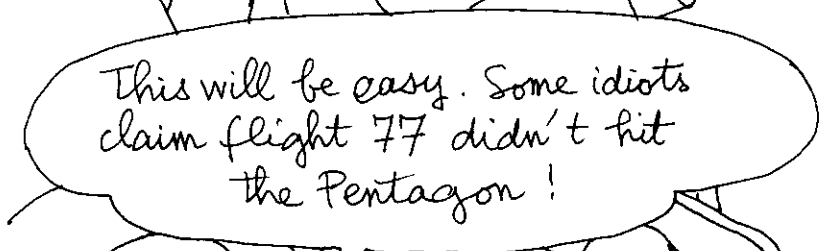

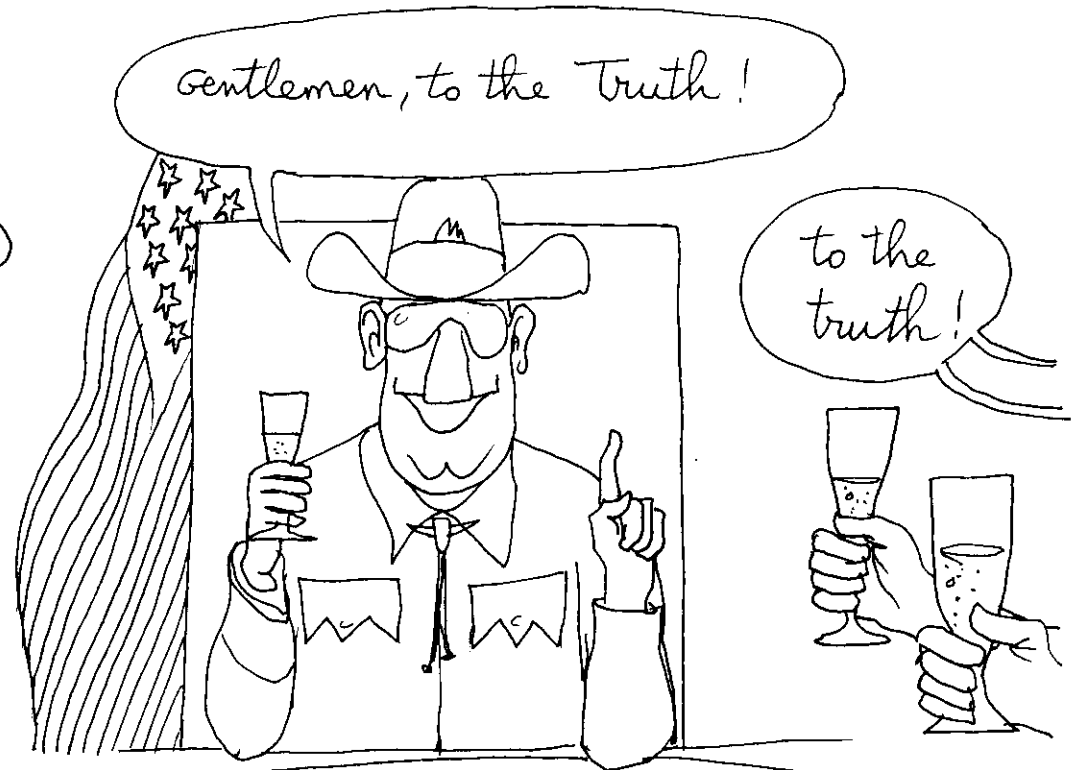



A friend at the Pentagon told me all the cameras were out of order. With the videos there would be no question

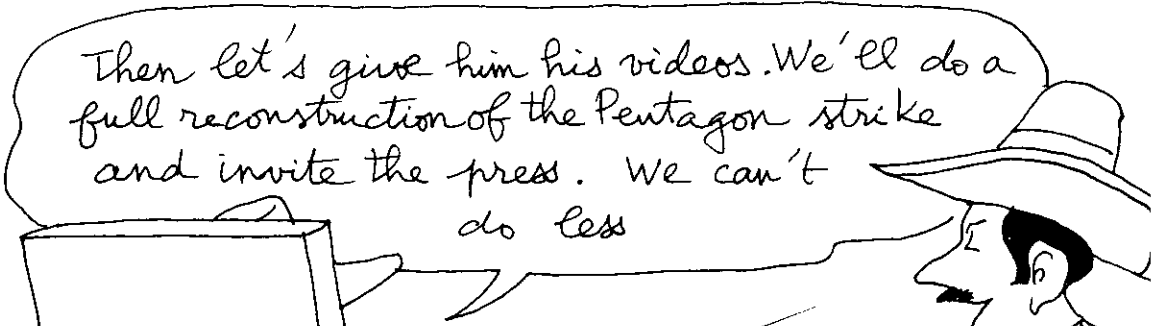

Then let's give him his videos. We'll do a full reconstruction of the Pentagon strike and invite the press. We can't do less



Poor George. Everything went wrong that day

Yep!



So, gentlemen what do we need?

First we need the building plans

no problem, the architect is a member of my club

We don't need to build it all. Only the side that was hit

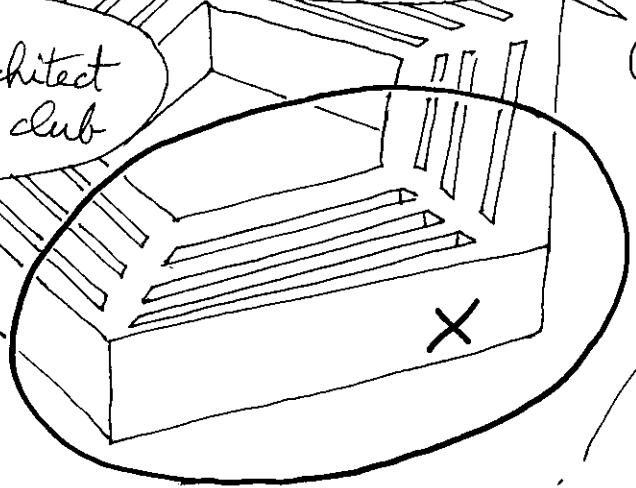

Yeah!



I calculated it, and it would only be one-fifth of the cost

Next, we need the plane. Any of you have stock in Boeing?

why not get one used? My cousin has an Airline in Asia

What about the corpses?

my brother in law is a doctor

out of the question. Too expensive

What about the earthquake last week end in China. Their prices are the lowest even with shipping

Does he have used planes?

all of them!



Anything else?
What about the grass?

Well, gentlemen, I think
that covers everything

Big John's idea should really
give George a boost. But I have
one question. Who's going to
fly the plane?

I'll get my gardener on it



Don't you have a private jet?

No, Frankie. Just ask him if an automatic pilot can take off and land a jet by itself

ye, it's the latest model

Ask your pilot!

You want my pilot to be a kamikaze
He's the best one I ever had



Is my answer going to affect my salary?

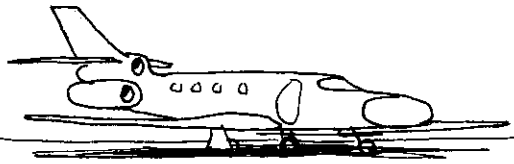

It's a long time everything is done by computer. During the final approach, the plane is automatically guided by a microwave beam. They let us fly the last 100 yards to preserve our image for the passengers

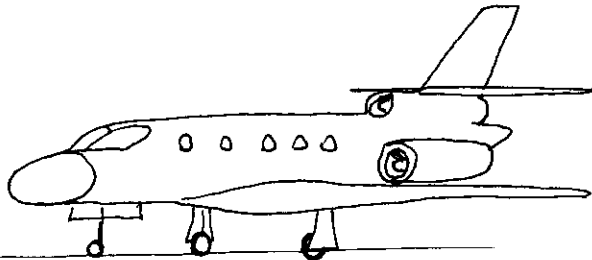

we were worried for nothing. These planes fly themselves, including a 757. It's standard equipment

So, where are we going to do this?

I have some land near Washington D. C. We could do it there

Then what about my ranch? The hunting wardens can't even get in

Are you crazy? It's too well protected. They would have interceptors on us in minutes

To sum up. The plane flies over the Pentagon at 7000^(*) feet, at over 400 miles per hour. In two and one half minutes it descends in a spiral until it is close to the ground and it begins its final approach towards its target. It cruises now at 460^(**) miles per hour. The distance between its motors and the grass is two feet^(***)

It hits the Pentagon, puncturing a 15^(*) foot hole in the reinforced facade. With the shock the wings fold back into the fuselage, bringing the engines into lines with the hole. The fuel is therefore positioned to vaporize the aircraft and the passengers, leaving only their fingertips, which can later be used to identify the bodies.

(*) 2300m (***) 800 km/h (***) 60cm

(*) 3m

Gentlemen, I think that with this reconstruction we'll be giving George the help he needs.

shall I give him the good news? We're golfing together this week.

No, let's make it surprise George loves a good surprise

THE END

8